

WIRING — FACTORY and INSTALLATION

Models R13X & R25X Retail Series

Models C13X & C25X Commercial Series

Single and Two Product Twin Self Contained Dispenser
With Solenoid Flow Control Valves (see note 13)
with Petrovend Kardguard K800 *

Refer to Owners Manual for Optional Interface Methods

* = Trade name of Petrovend.

WARNING: When connecting to a mechanical pump console or fleet system as shown in this diagram, jumpers MUST re-positioned on the dispenser's PS/IO board BEFORE AC power is applied. Failure to move jumpers will cause damage to the dispenser's electronics. Please see installation manual for jumper information.

Refer to Manual for Jumper Details

CPU Jumper Configuration

Power Supply Jumper Configuration

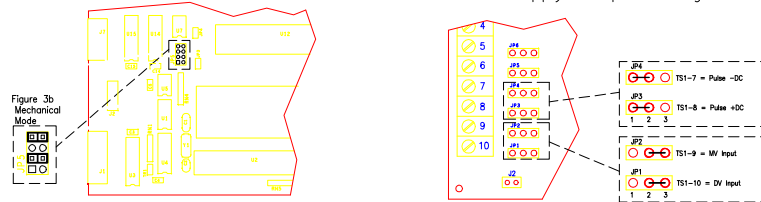

DC PULSE
VALVE INPUT

NOTES:

- All wiring must be installed in accordance with National Electrical Code (NFPA #70), automotive and marine service station code (NFPA #30A), and all state and local codes.
- Pull a green 12 AWG or larger ground wire and secure to the ground screw in the dispenser junction box. Do not rely on metal conduit as ground. Each dispenser junction box and interconnection box chassis must be within 1 ohm of earth ground.
- All specified wiring gauge is minimum. Use only stranded wire with THHN insulation. Do not reuse old wire.
- Do not use PVC conduit. Use only rigid metal conduit.
- Dispenser power (CB-1) must be a dedicated circuit. A maximum of two (2) dispensers may be placed on one (1) dispenser power circuit breaker. If more than one (1) dispenser power circuit breaker is used, all dispenser power circuit breakers must be installed on the same AC line phase.
- Circuit breakers are supplied by the customer.

Circuit Breaker Identification

- CB-1 Dispenser Power *
- CB-2 Lamp Power **
- CB-3 Motor Power ***

- * No more than two (2) dispensers per circuit breaker.
- ** No more than five (5) dispensers per circuit breaker.
- *** No more than one (1) pump motor per circuit breaker.

All circuit breakers shown are neutral breaking type.

- Dispenser is factory wired for 115 Vac or 230 Vac operation. This may not be changed in the field.
- Motors are dual voltage (115 Vac / 230 Vac) and are factory wired for 115 Vac. If 230 Vac operation is desired, set motor switch accordingly and field wire with appropriate voltage and color coded wire.
- One (1) motor circuit breaker (CB-3) per dispenser.
- If 115 Vac pumps motors are used, install 115 Vac motor circuit breaker (CB-3) on the AC line phase opposite the AC line phase where the dispenser power circuit breakers (CB-1) are installed.
- Two (2) Green (GRN) pigtail ground wires on each Power Supply / IO circuit board must be bonded to the ballast box chassis ground via the studs provided.
- N/A
- Valves are not present on models
R13X-XXXXXX--
R25X-XXXXXX--
C13X-XXXXXX--
C25X-XXXXXX--
X = Any valid option code

- Product "B" components are not present on models R13X- & C13X-.
- BLU wire color for 115 Vac valves. YEL wire color for 230 Vac valves.
- N/A
- N/A
- If an intercom system is used, DO NOT run the intercom and pump wires in the same conduit. Otherwise, electrical interference may occur with the intercom system or pump data communications.
- Refer to lamp ballast label for ballast/lamp wiring instructions.

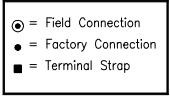
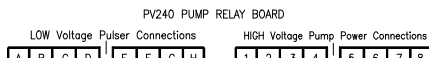
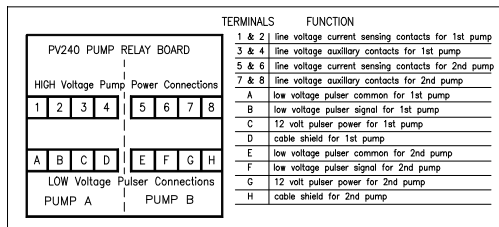
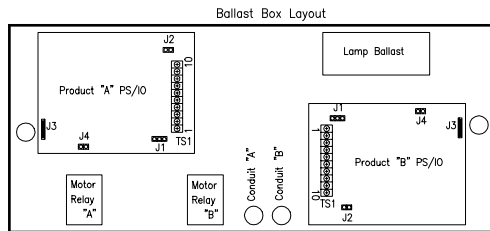

Electrical Ratings	
Dispenser Power	120 Watts 115 / 230 Vac
Lamp Power	90 Watts 115 / 230 Vac
Main Control Valves	15 Watts 115 / 230 Vac
40 A, 115 / 230 Vac	Solid State
Motor Relays	
Motor	3/4 H.P. 115 / 230 Vac
Encoder	30 mA, 5 Vdc
Customer Pump Switch	Intrinsically Safe
	Magnetic Reed Switch
	Intrinsically Safe

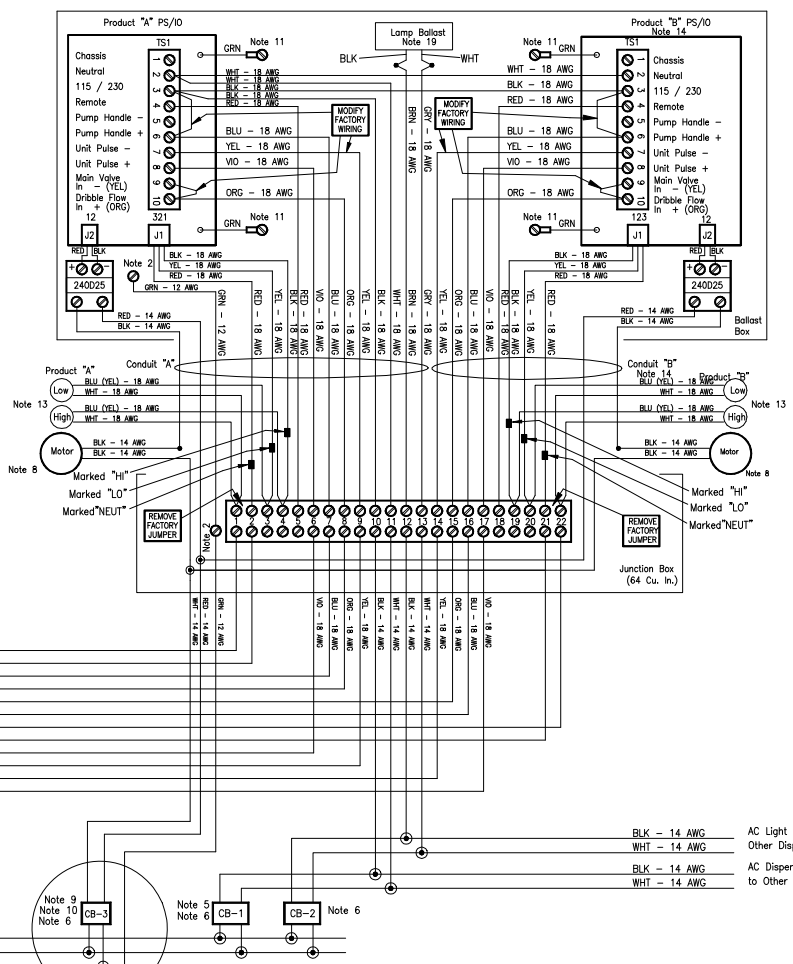
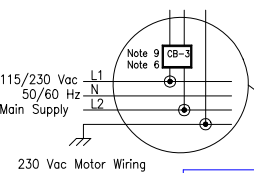

WIRING DIAGRAM — GO PUMP SELF CONTAINED — W/PETROVEND