

Bennett Low Profile Satellite Model

LPS

Installation Manual

Only Trained Personnel May Work on This Equipment

Includes Instructions For:

LPS40 Series Satellite

LPS60 Series Satellite

Compatible with:

2200 Big Squirt Truck Masters,

GoPump Series Masters,

4000 Series Masters,

3900 Series Masters,

3100-3600 Series Masters,

and 3700-3800 Series Masters

READ THIS BOOK

This book has important information for safe installation and operation of this equipment. Read and understand this book before applying power. Keep this book and tell all service personnel to read this book. If you do not follow the instructions, you can cause bodily injury, death or damage to the equipment.

For new books visit our web page at:

<http://www.bennettpump.com>



105993 Rev B 09/07

Table of Contents

Safety Instructions	3
Product Specifications	4
General Installation Information	4
Mechanical Installation Requirements	5
Determining the Number of Product Supply Pipes Needed	5
Determining the Correct Position of the Product Supply Lines	5
Underground Installation Requirements	5
Mechanical Installation Drawings	6
Wiring Instructions	6
Determining the Number of Wires Needed	6
Instructions for Earth Grounding the Equipment	7
Connecting the Wires	8
Finishing the Dispenser Wiring Installation	10
Satellite Start-up and Checklist	11
Base Dimensions Drawings	12
Field Electrical Wiring Diagram	13
Warranty Registration Card	14
Bennett Warranty	15

NOTICE

Not all equipment covered in this manual is listed by Underwriters Laboratories. Only those products that bear the Listing Mark of Underwriters Laboratories are listed.



IMPORTANT

Examine the shipment immediately upon arrival to make certain there has been no damage or loss in transit. Bennett Pump Company, as shipper, is not liable for the hazards of transportation. Please make damage claims directly to the truck line.

Safety Instructions

WARNING ADVERTISSEMENT ADVERTENCIA

For the safe installation of this equipment, read and understand all warning and cautions. Look for these warnings:

-  **“DANGER”** means: If you do not follow the instructions, severe injury or death will occur.
-  **“WARNING”** means: If you do not follow the instructions, severe injury or death can occur.
-  **“CAUTION”** means: If you do not follow the instructions, damage can occur to the equipment.

 **DANGER:** Fire, explosion, injury or death will occur if fuel filters are changed by untrained personnel. Make sure only trained personnel change filters.

 **DANGER:** To prevent injury to you from vehicles and onlookers, always place a barrier around this equipment before performing service or maintenance.

 **DANGER:** Gasoline is flammable.
NO SMOKING OR OPEN FLAME.

 **DANGER:** Disconnect all power to this equipment and associated submerged pump(s) during installation, service or any maintenance, i.e., changing filters.

 **WARNING:** You must have training in the installation, service or maintenance of this equipment (dispenser, pump, console, control box or submerged pump) before working on it. Maintenance repairs must be done by authorized personnel only. Warranty work may only be performed by Bennett certified technicians.

 **WARNING:** To prevent electric shock, keep the electrical parts of the dispenser dry.

 **WARNING:** Electronic components are static sensitive. Use proper static precautions (static straps) before working on the equipment.

 **WARNING:** The emergency shut-off valve (also called the fire valve, shear valve or impact valve) must be closed when service or maintenance is performed on this equipment.

 **WARNING:** You must have training in the operation and programming of this dispenser before using it. READ THE BOOK.

 **WARNING:** Make sure this equipment is correctly grounded. Failure to do will cause injury or damage equipment or improper operation.

 **WARNING:** When anchoring the dispenser, always level the dispenser with shims before bolting to the island. DO NOT shim just the middle of the dispenser and bolt down.

 **CAUTION:** Do not drill holes in fuel dispensers. Holes can cause failure of the electronic equipment. The warranty will become void. Use only adhesive backed sign mounting brackets.

READ AND UNDERSTAND ALL WARNING LABELS ATTACHED TO THE DISPENSER

Product Specifications

POWER REQUIREMENTS

Valve Power 115 VAC, 60 Hz or 230 VAC, 50 Hz. at 15 watt.
 Handle Switch Rating (Mechanical).....115VAC / 230VAC, 0.5 Amp.
 Handle Switch Rating (Electronic).....12VDC

ENVIRONMENTAL REQUIREMENTS

Operating Temperature Range +40°C
 Humidity: 0-95% condensing

DIMENSIONS

LPS Series 20 1/16" Wide x 22" Deep x 51" High

DETERMINING THE MODEL NUMBER AND THE DISPENSER FEATURES

Determine the model number of the satellite dispenser from the serial plate located on the side. Utilizing the chart below determine the features of the satellite dispenser to be installed. Understanding the features of the dispenser to be installed will be helpful in understanding the proper installation of the dispenser.

How a Model for the Horizon Series Dispensers is Made Up.

Dispenser Identification Number for the Low Profile Satellite									
L	P	S	XX	-	X	-	XXX	-	X
			Cabinet Color: W=White, G=Green, B=Black, R= Red						
			Voltage Selection: 115= 115VAC, 230 - 230VAC.						
			Number of hoses: 1 = single hose; 2 = two hose, two product.						
			Speed Rating: 40 for 40GPM (150LPM); 60 for 60GPM (225LPM).						
Satellite Dispenser Series Identifier									

General Installation Information

IMPORTANT

Examine the shipment immediately upon arrival to make certain there has been no damage or loss in transit. Bennett Pump Company, as shipper, is not liable for the hazards of transportation. Please make damage claims directly to the truck line.

Please read these instructions carefully and read all tags attached to the satellite dispenser before starting installation. A satellite dispenser that is not properly installed will not perform properly and will void Bennett's limited warranty.

Installation must be in accordance with the National Electrical Code (NFPA 70), the Automotive and Marine Service Station Code (NFPA 30A), and all state and local codes.

For complete instructions for installing underground liquid storage systems, order "Recommended Practices for Installation of Underground Liquid Storage Systems" from the Petroleum Equipment Institute, P.O. Box 2380, Tulsa, OK 74101.

Mechanical Installation Requirements

DETERMINING THE NUMBER OF PRODUCT SUPPLY PIPES NEEDED

Determine the satellite dispenser's model number from the serial tag located on the side of the dispenser or in the head of the dispenser, depending on the type. Locate the model number in the table below to determine the number of product pipes required.

Number of supply pipes needed by model.

LPS40 -1-XXX-X	Use 1 product line from the Master to the Satellite.
LPS40 - 2-XXX-X	Use 1 product line from the first Master to this satellite. Use 1 product line from the second Master to this Satellite.
LPS60 - 1-XXX-X	Use 1 product line from the Master to the Satellite.
LPS60 - 2-XXX-X	Use 1 product line from the first Master to this satellite. Use 1 product line from the second Master to this Satellite.

All models require an underground metal conduit routing from the master to the Satellite. Twin Satellites require a conduit from each master.

Note: All supply lines are 1-1/2" schedule 40 galvanized pipe or approved fiberglass pipe.

Note: All supply lines must have a UL listed emergency shut-off valve installed at the base of the Satellite.

DETERMINING STUB UP POSITIONS IN THE CONTAINMENT SUMP

Figure 1 will indicate the location of the piping and conduit connections for the dispenser. Plan your installation to locate these items according to these prints.

The satellite dispenser must be mounted on a concrete foundation. Do not pour concrete around the product pipes or electrical conduit. The use of a UL approved containment sump designed for this Bennett Satellite Dispenser Model is highly recommended. Follow the containment sump manufacturer's installation instructions for proper installation.

Anchor the satellite dispenser to the island with four anchor bolts through the base frame. **WHEN ANCHORING THE SATELLITE DISPENSER**, always level the dispenser with shims before bolting to the island. Place the shims at the location of the anchor bolts so the dispenser frame is not distorted when the anchor bolts are tightened down. The satellite dispenser must be bolted to the island. Do not skip this step.

Pipe Installations Requirements

Dig a trench between the master and the satellite dispenser foundation. It must be deep enough to place the product pipe at least 18 inches below the surface of the ground (at its highest point). The trench should be as straight as possible to avoid as many elbows and bends in the line as possible. All piping must conform to local fire regulations. Use new 1-1/2" or larger EPA approved pipe. All joints in the product line must be tight. Flex pipe must be used at the ends of the horizontal pipe to prevent leaks which might develop through ground movement from frost heaving of the ground or the pump island settling. The flex pipe under the dispenser also aids proper alignment of the product union.

The installation must be installed and used in accordance with Federal, State, Local, and National Electrical code NFPA #70 and Automotive and Marine service station code NFPA 30A.

When a new dispenser is attached to an old underground installation, the tanks should be cleaned and tested for leaks. Any water accumulation in the tank must be removed. Bennett Pump Company is not responsible for any damage to the dispenser or for improper operation due to accidents, abuse, or faulty installation. We highly recommend installing new wires in the underground metal conduits.

NOTE: All piping must be clean of foreign debris, such as: oil, grease and shavings.

Mechanical Installation Drawings

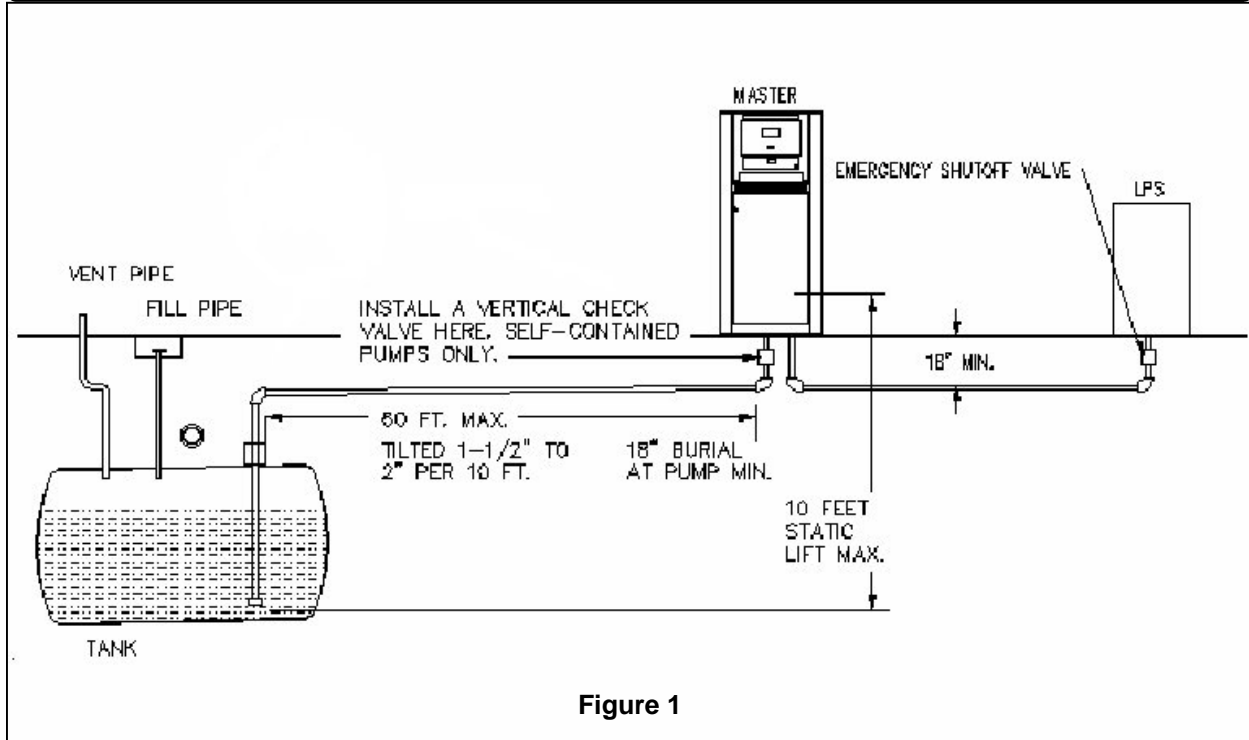

NOTE: Make sure the installation conforms to the new EPA regulations for underground storage tanks.

PIPE INSTALLATION FOR REMOTE DISPENSERS

Install an UL listed emergency shut-off valve, designed to close automatically in the event of severe impact or fire exposure, in the Satellite dispenser supply line at the base of the dispenser. The valve will also permit safe inspection and maintenance. Follow the installation instructions for the valve being installed. See Figure 2.

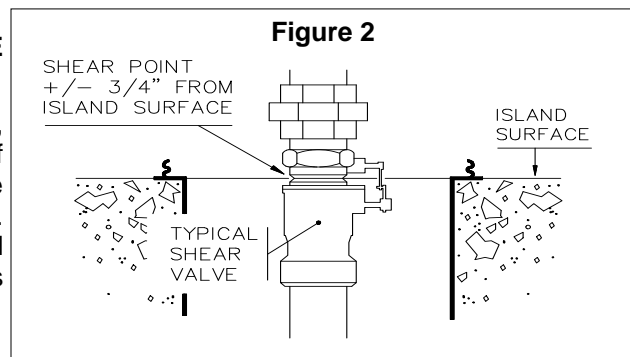

Wiring Instructions

DETERMINING THE NUMBER OF WIRES NEEDED (115 or 230 Volt installations).

There are two modes of operation. The Exclusive mode will allow only one nozzle, either the Master or Satellite to be active at one time. In this method the Master hose can pump product while the Satellite's nozzle is off. When the Satellite nozzle is turned on the Master's nozzle will shut off until the Satellite's nozzle is turned off. This method of operation is required by law or by the Fire Marshall in some areas of the country. Check your local regulations to determine if this method of operation is required.

Wiring Instructions

The second method of operation is the Simultaneous mode. In the Simulation mode both nozzles will allow product flow once they are activated. The Master nozzle must be turned on first and then the Satellite nozzle may be opened to allow simultaneous flow from both nozzles.

Wires required For Proper Installation (per hose):

For Mechanical Masters:

Exclusive Mode

- 1-Brown 18 AWG for Pump Handle.
- 1-Blue 18 WG for Pump Handle Common.
- 1-Yellow 18 AWG for Slow Flow Valve Hot.
- 1-Black 18 AWG for High Flow Valve Hot.
- 1-Green 12 AWG for Earth Ground.

Simultaneous Mode

- 1-Blue 18 WG for Pump Handle Common.
- 1-Yellow 18 AWG for Slow Flow Valve Hot.
- 1-Black 18 AWG for High Flow Valve Hot.
- 1-Green 12 AWG for Earth Ground.

For Electronic Masters:

Exclusive & Simultaneous Mode

- 1-Brown 18 AWG for Pump Handle.
- 1-Blue 18 WG for Pump Handle Common.
- 1-Yellow 18 AWG for Slow Flow Valve Hot.
- 1-Black 18 AWG for High Flow Valve Hot.
- 1-Red 18 AWG for Solenoid Valve Neutral.
- 1-Green 12 AWG for Earth Ground.

Note that if the LPS is controlling two hoses you must only run (1) ground to one of the Masters.

Do Not run two grounds to both Masters!

Use only stranded wire with listed gas and oil resistant insulation. We recommend type THHN.

Pull these wires through the underground metal conduit leaving at least 72 inches at both ends for proper termination. **Place the wire separator onto the wires before terminating the wires, see Figure 3.**

Wiring Notes: These notes are must do requirements to ensure a successful installation that meets Bennett's limited warranty requirements.

1. Check with Federal, State and Local Codes for conduit use in your area. Bennett recommends rigid metal conduit.
2. Use only stranded wire with listed gas and oil resistant insulation. Do not use a wire gauge smaller than listed on the Bennett wiring diagrams.
3. **DO NOT SPLICE WIRES THEY MUST BE DIRECT RUNS.**
4. When the dispenser wires are pulled through the underground conduit leave at least 72" higher than the base of the dispenser to allow enough length to reach the satellite terminal strip.
5. The wire separator (supplied with the pump) must be installed on the wires as they exit the pump conduit before the wires are terminated to the power board. The wire separator is needed to properly seal the conduit in the last step of installation.

INSTRUCTIONS FOR EARTH GROUNDING THE EQUIPMENT



WARNING: Failure to properly ground the equipment can cause injury or damage to the equipment and will void the Bennett limited warranty.

This product must be properly grounded. Each satellite dispenser requires a 12-gauge earth ground wire. Grounding provides a path of least resistance for electric current to reduce the risk of electric shock. Grounding is also required to protect the dispenser's computer from external electrical noise generating devices. The ground wire connection must provide 1 ohm (or less) resistance to earth ground. To establish a good earth ground, follow this procedure:

1. Connect a 12-gauge (minimum), green stranded wire to the grounding terminal near the terminal block in the Master's electronic head or junction box.
2. Pull the wire through the rigid metal conduit and connect it to the grounding terminal in the Satellite junction box. Do NOT rely on the metal conduit as a ground.

DO NOT USE WIRE NUTS ON GROUND WIRES. USE COMPRESSION CONNECTORS ONLY.

Connecting the Wires

INSTRUCTIONS FOR CONNECTING THE SIGNAL WIRES

Once you have anchored, piped, and pulled the wires for the Master and LPS in accordance with the National Electrical Code (NFPA 70), the Automotive and Marine Service Station Code (NFPA 30A), and all state and local codes then you are ready to electrically connect the LPS to the Master.

Connecting the Satellite (for Mechanical Masters only) -

Exclusive Mode

1. At the Satellite, connect the Brown 18 AWG wire to the Brown switch wire in the satellite's junction box. Use a compression connector.
2. Connect the Blue 18 AWG wire to the Blue switch wire in the satellite's junction box. Use a compression connector.
3. Using a compression connector connect the Yellow 18 AWG wire to the Yellow valve wire in the Satellite junction box.
4. Using a compression connector connect the Black 18 AWG wire to the Black valve wire in the Satellite junction box.
5. Using a compression connector connect the Red 18 AWG (Satellite's Solenoid Valve) wire to the Purple switch wire.
6. The Green Ground wire was connected in the step before this one.

Simultaneous Mode

1. Connect the Blue 18 AWG wire to the Blue switch wire in the satellite's junction box. Use a compression connector.
2. Cap off the Brown wire in the satellite's junction so it does not short to the box.
3. Using a compression connector connect the Yellow 18 AWG wire to the Yellow valve wire in the Satellite junction box.
4. Using a compression connector connect the Black 18 AWG wire to the Black valve wire in the Satellite junction box.
5. Using a compression connector connect the Red 18 AWG (Satellite's Solenoid Valve) wire to the Purple switch wire.
6. The Green Ground wire was connected in the step before this one.

Connecting the Master To:

2200 Series Big Squire Truck Pump

- please refer to the *Horizon 2200 Installation Manual (p.n. 104613)* for the *Satellite Wiring Diagram*.

1. Locate the Master / Satellite Board located in the 2200 Master.
2. From the LPS connect the brown wire from the Handle Switch to TS1 of the Master / Satellite Board (from the Master) on pin 1.
3. From the LPS connect the blue wire from the Handle Switch to TS1 of the Master / Satellite Board (from the Master) on pin 2.
4. From the LPS cap off the brown wire from the Handle Switch.
5. From the LPS connect the red wire from the Solenoid Valve to TS2 of the Master / Satellite Board (from the Master) Pin 3 (closest to the corner of the board).
6. From the LPS connect the black wire from the Solenoid Valve to TS2 of the Master / Satellite Board (from the Master) Pin 1 (closest to TS1).
7. From the LPS connect the yellow wire from the Solenoid Valve to TS2 of the Master / Satellite Board (from the Master) Pin 2 (center).
8. Note that configuring it for Simultaneous or Exclusive mode is done by a simple jumper located on the Master Satellite Board.
9. Locate the Installation Manual of the Master dispenser and follow its directions / diagram.

Connecting the Wires

Connecting the Master To:

GoPump Series ("C" and "R") Pumps and Dispensers

1. Locate the valve wire harness in the GoPump series Master where it connects to the power supply.
2. Wiring for the Exclusive mode:
Approximately 6 inches away from the power supply connector cut the Red valve wire. Connect the end of the Red wire that routes to the valve to the Brown 18 AWG wire going to the Satellite. Connect the end of the Red wire that goes to the power supply to the Blue 18 AWG wire going to the Satellite. Use only compression connectors, do not use wire nuts.
Wiring for the Simultaneous mode:
Approximately 6 inches away from the power supply connector attach an in-line splice (Bennett P/N A411301) to the Red valve wire. Place the Blue 18 AWG wire going to the Satellite into the splice and close the splice.
3. Again with the Master valve harness approximately 6 inches away from the power supply connector attach an in-line splice (Bennett P/N A411301) to the yellow valve wire. Place the Yellow 18 AWG wire going to the Satellite into the splice and close the splice.
4. Again with the Master valve harness approximately 6 inches away from the power supply connector attach an in-line splice (Bennett P/N A411301) to the Black valve wire. Place the Black 18 AWG wire going to the Satellite into the splice and close the splice.

3700 & 3800

- please refer to the 3000 Series Electronic Installation Manual (p.n. 107931) for the Satellite Wiring Diagram.

*NOTE - You may have to purchase the Satellite Kit. For the 3700 the Kit Number is 109395. For the 3800 the Kit Number is 109390

1. Locate the Master / Satellite Board located in the 3700 or 3800. This is located just below the Main Display (CPU) Board.
2. From the LPS connect the brown wire from the Handle Switch to TS1 of the Master / Satellite Board (from the Master) on Pin 1.
3. From the LPS connect the blue wire from the Handle Switch to TS1 of the Master / Satellite Board (from the Master) on Pin 2.
4. In the LPS cap off the purple wire from the Handle Switch.
5. Connect the red wire from the LPS Solenoid Valve to TS2 of the Master / Satellite Board (in the Master) Pin 3 (closest to TS3).
6. Connect the black wire from the LPS Solenoid Valve to TS2 of the Master / Satellite Board (in the Master) Pin 1 (closest to TS1).
7. Connect the yellow wire from the LPS Solenoid Valve to TS2 of the Master / Satellite Board (in the Master) Pin 2 (center).
8. Note that configuring it for Simultaneous or Exclusive mode is done by a simple jumper located on the Satellite Board.
9. Locate the Installation Manual of the Master dispenser and follow its directions / diagram.

3100, 3200, 3300, 3400, 3600, 3900, and 4000 Series Mechanical Masters

1. Locate the terminal strip in the top junction box of the Mechanical Master.
2. Wiring for the Exclusive mode:
Disconnect the valve common (red) from the terminal strip position 1 (if side 2 then position 22).
Note: in some models there may be two common wires, disconnect both of these wires. Connect the disconnected common wire(s) to the Brown 18 AWG wire going to the Satellite. Connect the Blue 18 AWG wire going to the satellite, to the master's terminal strip position 1 (if side 2 then position 22). Use only compression connectors, do not use wire nuts.

Connecting the Wires

Mechanical Masters (continued...)

Wiring for the Simultaneous mode:

Connect the Blue 18 AWG wiring going to the Satellite, to the master's terminal strip position 1 (if side 2 then position 22).

3. Connect the Yellow 18 AWG wire going to the Satellite, to the low flow valve signal (yellow wire) on the master's terminal strip position 3 (if side 2 then position 20).

4. Connect the Black 18 AWG wire going to the Satellite, to the high flow valve signal (black wire) on the master's terminal strip position 4 (if side 2 then position 19).

Note: if no valves exist in the Master you will have to add valves to use the Exclusive mode. If the Simultaneous mode is used connect the Master as above and wire power to the valve control inputs on terminal strip position 5 and side 2 position 18, see the Master's installation instructions. This will switch the power provided to the satellite through the Master's electric reset, preventing the satellite's Nozzle from being used when the master dispenser is off.

FINISHING THE DISPENSER WIRING INSTALLATION

1. Wrap some "CHICO X" fiber around wires and push into conduit assembly to prevent potting from running down the length of the conduit. See Figure 3.
2. Using the wire separator provided, install one wire in each hole until all wires are separated. See Figure 3.
3. Push wire separator at least 3/4" into conduit.
4. Prepare potting compound according to directions.

NOTE: Use "CHICO" potting compound for sealing fittings in hazardous locations.

5. Using a funnel, pour potting into conduit, be sure to get potting in between each wire. See Figure 3.
6. Let stand until firm.

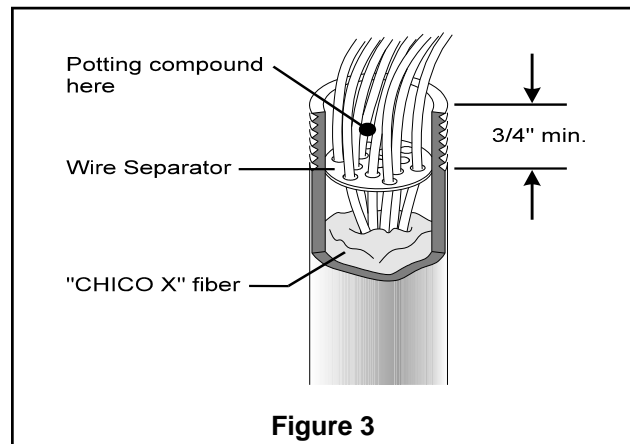

Satellite Start Up and Checklist



DANGER: Fire, explosion, injury or death will occur if fuel vapors are present. Make sure there are no vapors present before starting this procedure.



CAUTION: To prevent damage to the dispenser, follow the proper start-up procedures.

Before applying AC power to the dispenser and Satellite, follow this procedure:

1. Open the cabinet doors.
2. Check to make sure:
 - The components have not come loose during shipment.
 - The cables are properly connected and there are no torn cables or harnesses.
 - The pump handle harness is connected properly to the nozzle boots.
 - Make sure the 12-gauge Green ground wire is properly terminated in the Satellite and the Master. This ground connection must measure 1 ohm (or less) resistance to earth ground at the main electrical enclosure.
 - Make sure the wiring agrees with the wiring diagrams
3. Make sure the impact valves are closed.
4. Test the Master Dispenser according to the test procedure in the Master Dispenser installation instructions.
5. When the Master is working correctly turn on the master dispenser and dispense enough fuel to turn on the main valve. Then turn on the Satellite pump handle while feeling the solenoid valve with your hand. When the valve turns on you should feel and hear a click.
6. Once you are sure the solenoid valve is working properly open the fire valve and dispense fuel through the satellite nozzle. Test the nozzle to be sure the flow of fuel stops when the satellite handle is turned off. Also test the Exclusive or Simultaneous mode to be sure the operation is correct.
7. Replace the doors and re-fasten.

LPS Series Dimensional Diagram

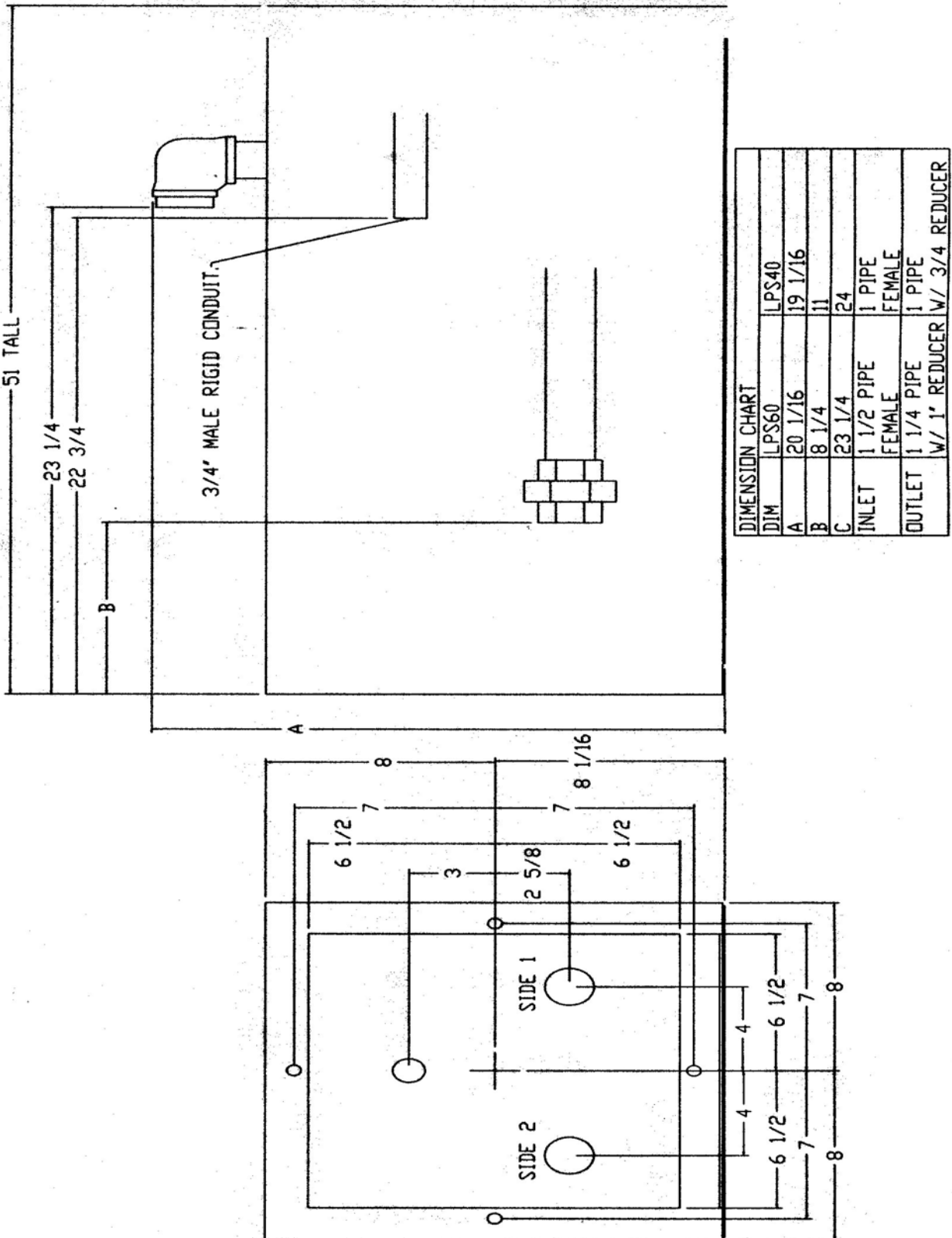

Figure 4

LPS Series Wiring Diagram

WIRING INFORMATION – FACTORY & INSTALLATION

MODEL LPS

FOR CONNECTION TO A MECHANICAL DISPENSER

SHOWN FOR SINGLE SIDE SATELLITES ONLY

NOTE: SEE INSTALLATION INSTRUCTIONS WITH SATELLITE KIT FOR CONNECTION TO ELECTRONIC DISPENSER

109393 – 3800 RETAIL SAT. KIT
109396 – 3700 COMM. SAT. KIT

WIRING FOR EXCLUSIVE FLOW (ONLY ONE ACTIVE HOSE)

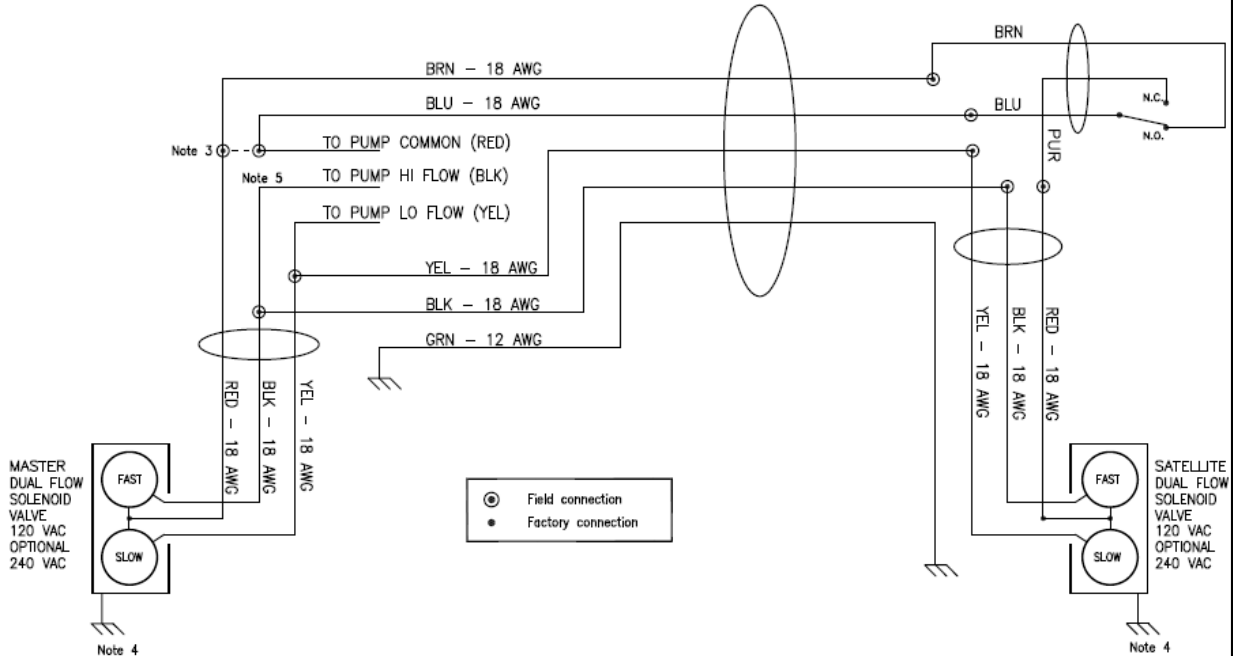

WIRING FOR SIMULTANEOUS FLOW

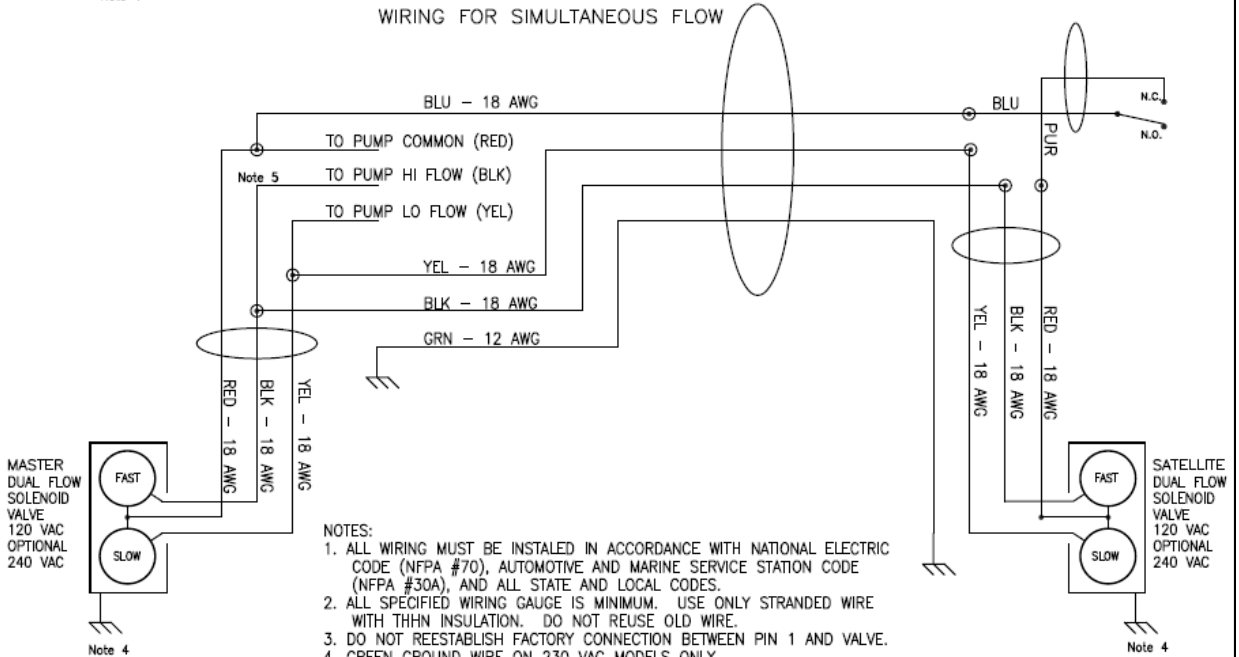

NOTES:

1. ALL WIRING MUST BE INSTALLED IN ACCORDANCE WITH NATIONAL ELECTRIC CODE (NFPA #70), AUTOMOTIVE AND MARINE SERVICE STATION CODE (NFPA #30A), AND ALL STATE AND LOCAL CODES.
2. ALL SPECIFIED WIRING GAUGE IS MINIMUM. USE ONLY STRANDED WIRE WITH THHN INSULATION. DO NOT REUSE OLD WIRE.
3. DO NOT REESTABLISH FACTORY CONNECTION BETWEEN PIN 1 AND VALVE.
4. GREEN GROUND WIRE ON 230 VAC MODELS ONLY.
5. ON MECHANICAL MODELS, CONNECTIONS MAY BE MADE DIRECTLY TO TERMINAL STRIP.

DIAGRAM PART NUMBER – 105715 C
P-0354

Figure 5

Warranty Registration

Figure 6 is an example of an equipment Warranty Registration Card. Each piece of Bennett equipment is registered at the factory. This card assures the owner of complete WARRANTY STATUS registration.

Return the completed equipment Warranty Registration Card to BENNETT, 1218 E. Pontaluna Road, Spring Lake, MI 49456 within five (5) working days of installation.

If the equipment Warranty Registration Card is not received and recorded at BENNETT, Status of Warranty may be difficult to establish.

WARRANTY REGISTRATION CARD		
<i>A separate registration card must be filled out for each piece of equipment at the site including the I.C. box and the console.</i>		
Model No.:	_____	Date of Installation: _____
Equipment Serial No.:	_____	Hose Number(s): _____
Bennett Invoice No.:	_____	Bennett Invoice Date: _____
Site Name:	_____	Site Phone: () _____
Site Address:		
City:	_____	State: _____ Zip _____
Owned by: _____		
Installed by: _____		
Sold By: _____		
Serviced By: _____		
WARRANTY REGISTRATION must be completed and mailed to BENNETT, Attention: Technical Services, Spring Lake, Michigan at time of installation		

Figure 6

Bennett Limited Warranty

Bennett Limited Warranty may apply to these products. For a copy of the current Bennett Limited Warranty, please contact Bennett Marketing Services and request a copy specifying the model number of the product and the country in which the product is installed.

Bennett Marketing Services can be contacted by mail, facsimile, telephone or e-mail at the locations specified below:

Bennett Pump Company
Marketing Services
1218 E. Pontaluna Road
Spring Lake, Michigan, USA 49456

Telephone from USA: 800.235.7618
Telephone from outside USA: 231.798.1310, Ext. 269
Facsimile: 231.799.6202
E-mail: sales@bennettpump.com
WEB: <http://www.BennettPump.com>

The material included in this Installation Manual is accurate at the date of publication. The intent of this manual is to assist. If further assistance is required, please contact the Bennett Technical Service Department at 1-800-4-BENNET (1-800-423-6638).

